

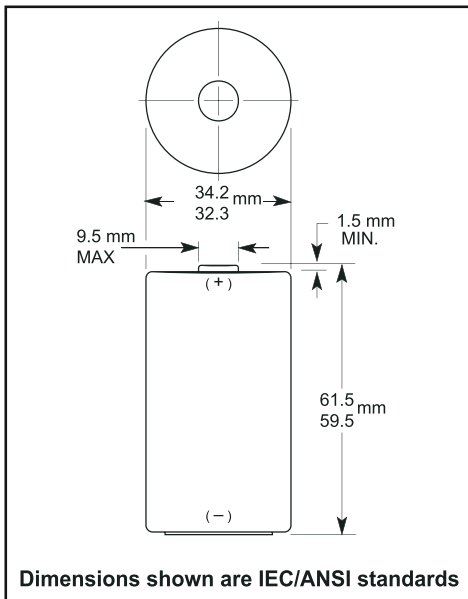

Nominal Voltage:	1.5 V
Operating Voltage	1.6 - 0.75V
Impedance:	136 m-ohm @ 1kHz
Typical Weight:	139 gm (4.9 oz.)
Typical Volume:	56.4 cm ³ (3.4 in. ³)
Terminals:	Flat
Storage Temperature Range:	-20 ^o C to 35 ^o C
Operating Temperature Range:	-20 ^o C to 54 ^o C (-4 ^o F to 130 ^o F)
ANSI:	13A
IEC:	LR20

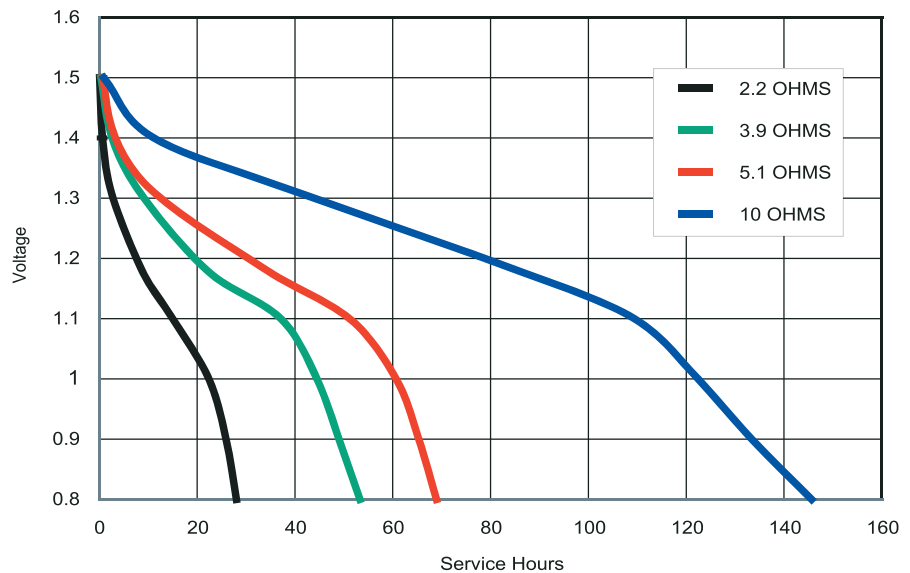

TYPICAL DISCHARGE CHARACTERISTICS AT 21 °C (70 °F)



DURACELL[®] BATTERIES

Berkshire Corporate Park
Bethel, CT 06801 U.S.A.
Telephone: Toll-free 1-800-544-5454
Internet: www.duracell.com

* Delivered capacity is dependent on the applied load, operating temperature and cut-off voltage. Please refer to the charts and discharge data shown for examples of the energy / service life that the battery will provide for various load conditions.

TYPICAL CONSTANT POWER DISCHARGE CHARACTERISTICS AT 21°C (70°F)

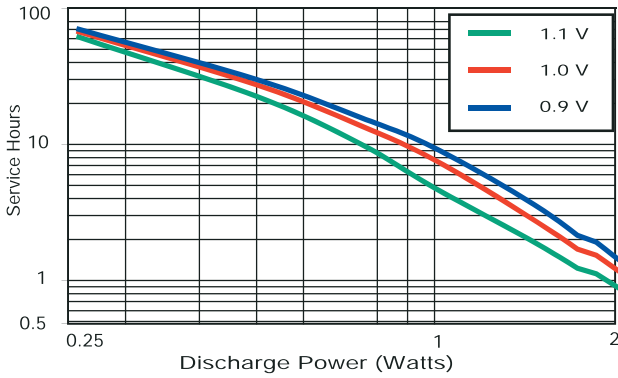

TYPICAL CONSTANT CURRENT DISCHARGE CHARACTERISTICS AT 21°C (70°F)

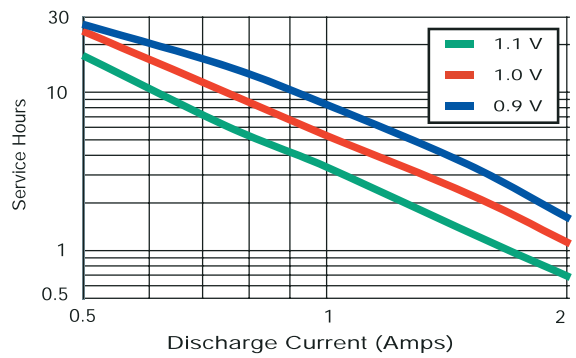

TYPICAL DISCHARGE CHARACTERISTICS AT 21°C (70°F)

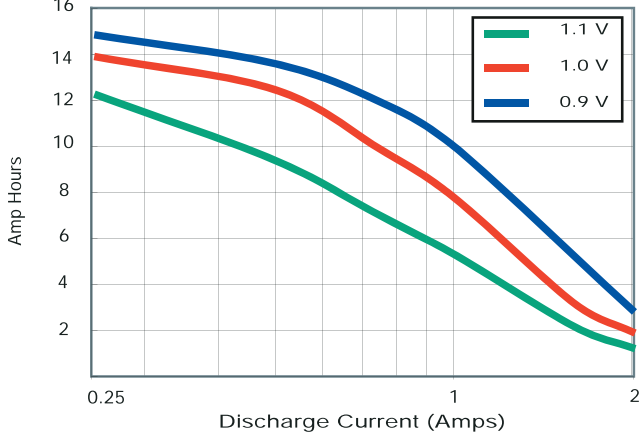

TYPICAL DISCHARGE CHARACTERISTICS AT 21°C (70°F)

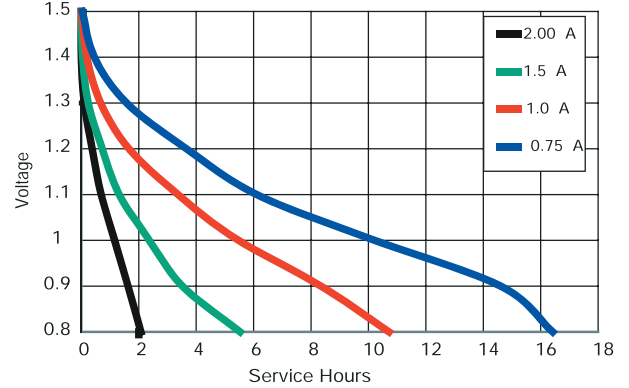

TYPICAL FLASHLIGHT TEST AT 21°C AND 0°C

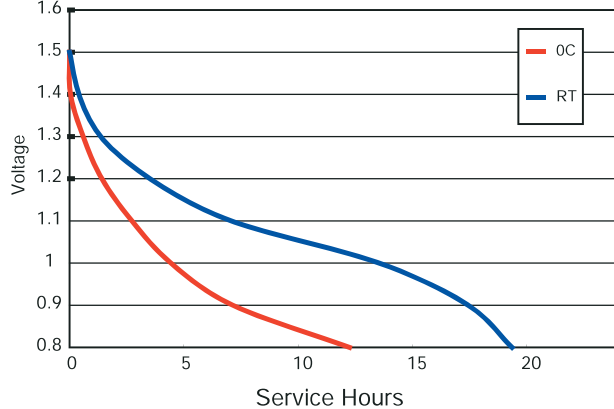

DURACELL[®]
BATTERIES

Berkshire Corporate Park
Bethel, CT 06801 U.S.A.
Telephone: Toll-free 1-800-544-5454
Internet: www.duracell.com

* Delivered capacity is dependent on the applied load, operating temperature and cut-off voltage. Please refer to the charts and discharge data shown for examples of the energy / service life that the battery will provide for various load conditions.

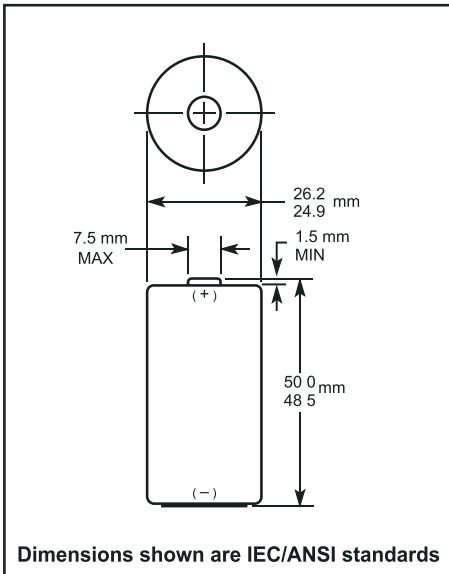

Nominal Voltage:	1.5 V
Operating Voltage	1.6 - 0.75V
Impedance:	150 m-ohm @ 1kHz
Typical Weight:	69 gm (2.4 oz.)
Typical Volume:	26.9 cm ³ (1.6 in. ³)
Terminals:	Flat
Storage Temperature Range:	-20°C to 35°C
Operating Temperature Range:	-20°C to 54°C (-4°F to 130°F)
ANSI:	14A
IEC:	LR14

TYPICAL DISCHARGE CHARACTERISTICS AT 21°C (70°F)

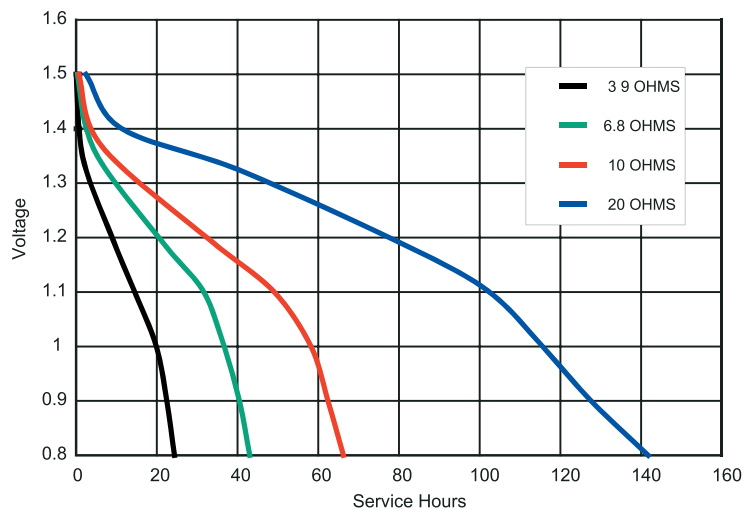

DURACELL[®] BATTERIES

Berkshire Corporate Park
Bethel, CT 06801 U.S.A.
Telephone: Toll-free 1-800-544-5454
Internet: www.duracell.com

* Delivered capacity is dependent on the applied load, operating temperature and cut-off voltage. Please refer to the charts and discharge data shown for examples of the energy / service life that the battery will provide for various load conditions.

TYPICAL DISCHARGE CHARACTERISTICS
AT 21°C (70°F)

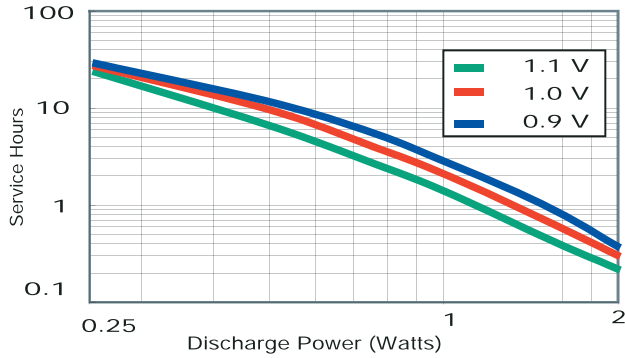

TYPICAL DISCHARGE CHARACTERISTICS
AT 21°C (70°F)

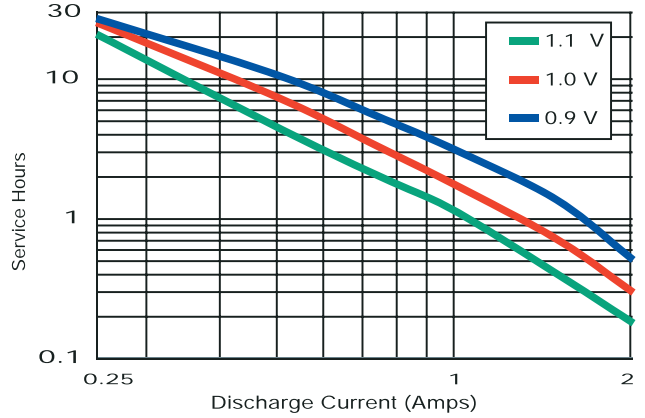

TYPICAL DISCHARGE CHARACTERISTICS
AT 21°C (70°F)

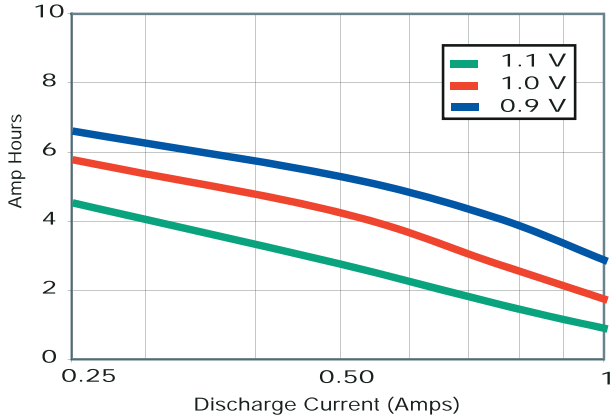

TYPICAL DISCHARGE CHARACTERISTICS
AT 21°C (70°F)

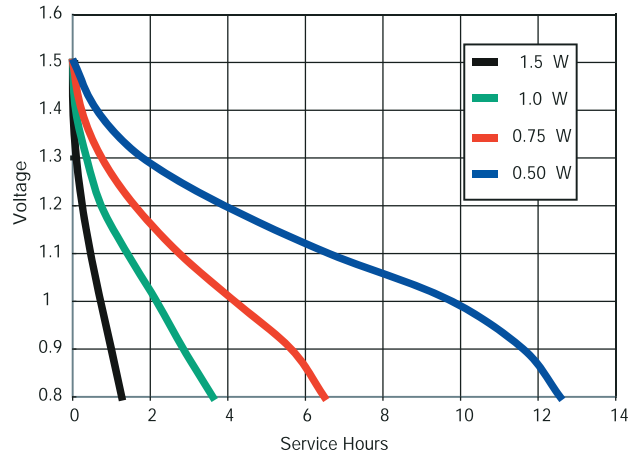

TYPICAL FLASHLIGHT TEST
AT 21°C AND 0°C

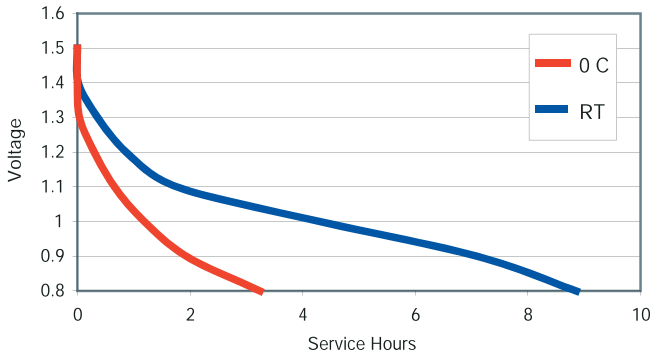

DURACELL[®]
BATTERIES

Berkshire Corporate Park
Bethel, CT 06801 U.S.A.
Telephone: Toll-free 1-800-544-5454
Internet: www.duracell.com

* Delivered capacity is dependent on the applied load, operating temperature and cut-off voltage. Please refer to the charts and discharge data shown for examples of the energy / service life that the battery will provide for various load conditions.

Alkaline-Manganese Dioxide Battery

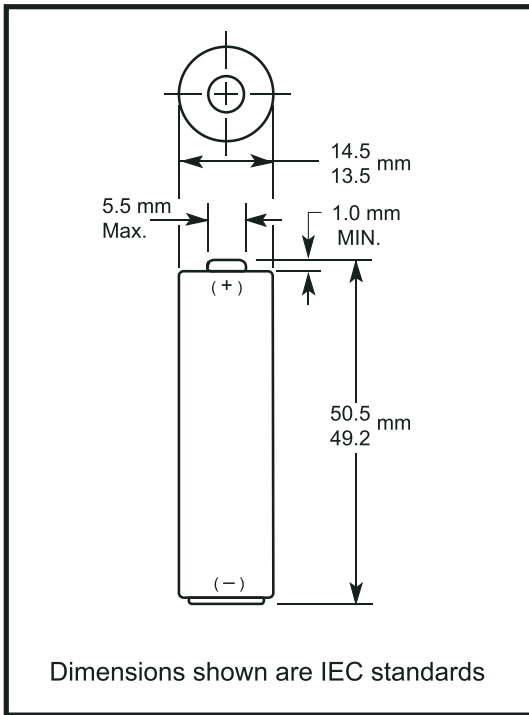

Nominal Voltage:	1.5 V
Operating Voltage	1.6 - 0.75V
Impedance:	120 m-ohm @ 1kHz
Typical Weight:	24 gm (0.8 oz.)
Typical Volume:	8.4 cm ³ (0.5 in. ³)
Terminals:	Flat
Storage Temperature Range:	-20 ^o C to 35 ^o C
Operating Temperature Range:	-20 ^o C to 54 ^o C (-4 ^o F to 130 ^o F)
ANSI:	15A
IEC:	LR6

TYPICAL DISCHARGE CHARACTERISTICS AT 21°C (70°F)

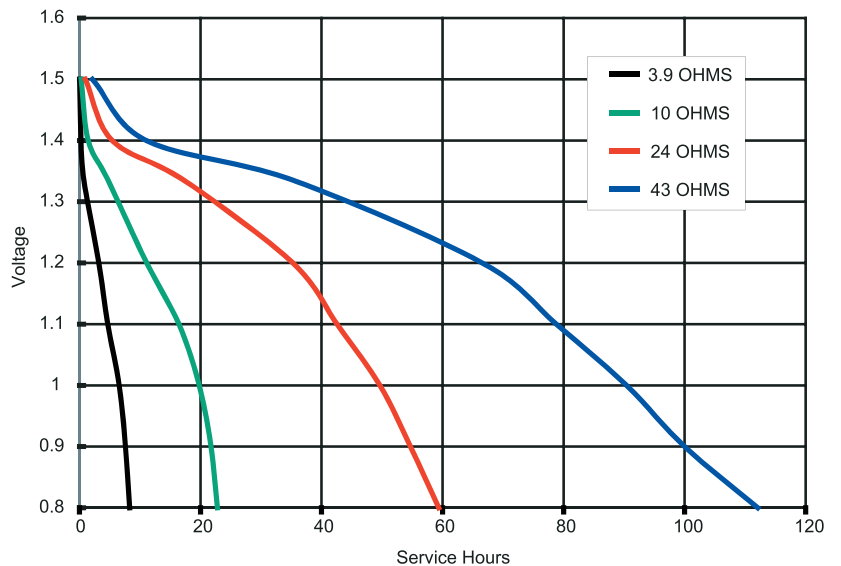

DURACELL[®] BATTERIES

Berkshire Corporate Park
Bethel, CT 06801 U.S.A.
Telephone: Toll-free 1-800-544-5454
Internet: www.duracell.com

* Delivered capacity is dependent on the applied load, operating temperature and cut-off voltage. Please refer to the charts and discharge data shown for examples of the energy / service life that the battery will provide for various load conditions.

TYPICAL CONSTANT CURRENT DISCHARGE CHARACTERISTICS AT 21°C (70°F)

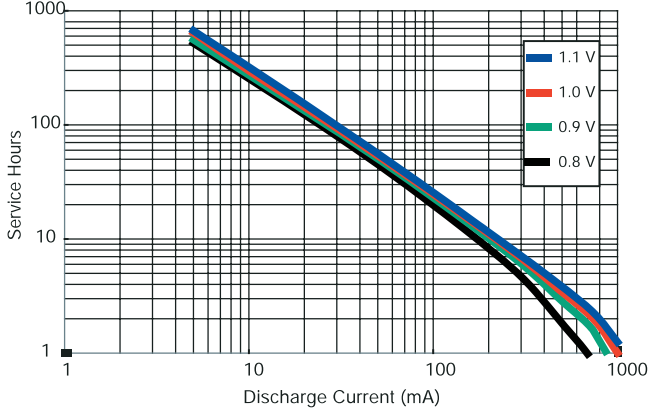

TYPICAL DISCHARGE CHARACTERISTICS AT 21°C (70°F)

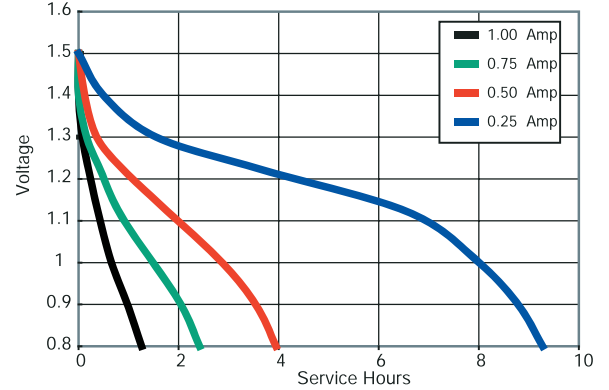

TYPICAL DISCHARGE CHARACTERISTICS AT 21°C (70°F)

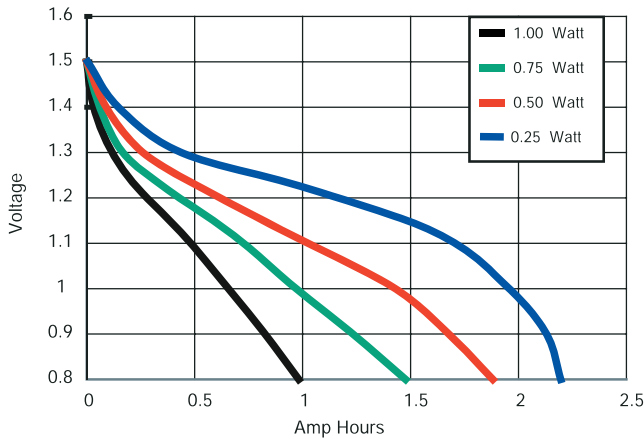

TYPICAL DISCHARGE PERFORMANCE AT 21°C (70°F)

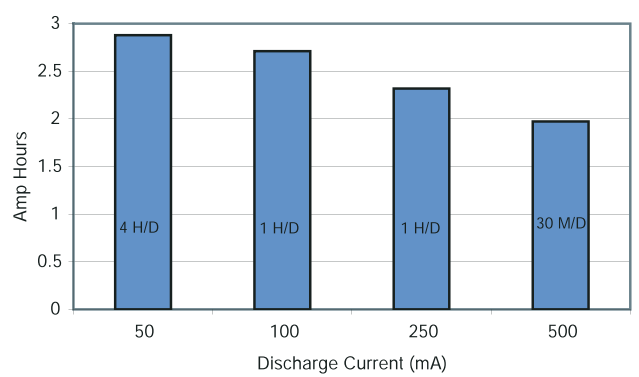

TYPICAL DC RESISTANCE CHARACTERISTICS AT 21°C (70°F)

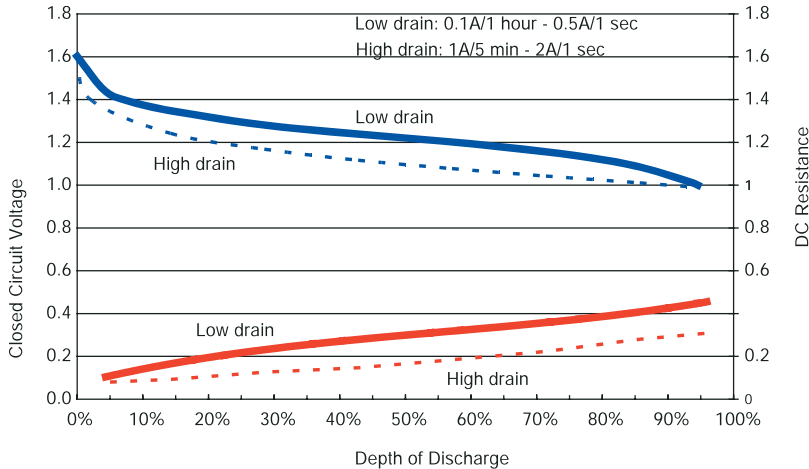

* Delivered capacity is dependent on the applied load, operating temperature and cut-off voltage. Please refer to the charts and discharge data shown for examples of the energy / service life that the battery will provide for various load conditions.

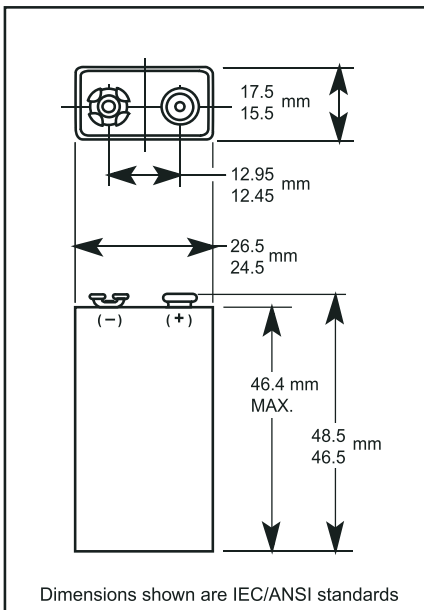

Nominal Voltage:	9 V
Operating Voltage:	9.6 - 4.8 V
Impedance:	1,700 m-ohm @ 1kHz
Typical Weight:	45 gm (1.6 oz.)
Typical Volume:	22.8 cm ³ (1.4 in. ³)
Terminals:	Miniature Snap
Storage Temperature Range:	-20°C to 35°C
Operating Temperature Range:	-20°C to 54°C (-4°F to 130°F)
ANSI:	1604A
IEC:	6LR61

TYPICAL DISCHARGE CHARACTERISTICS AT 21°C (70°F)

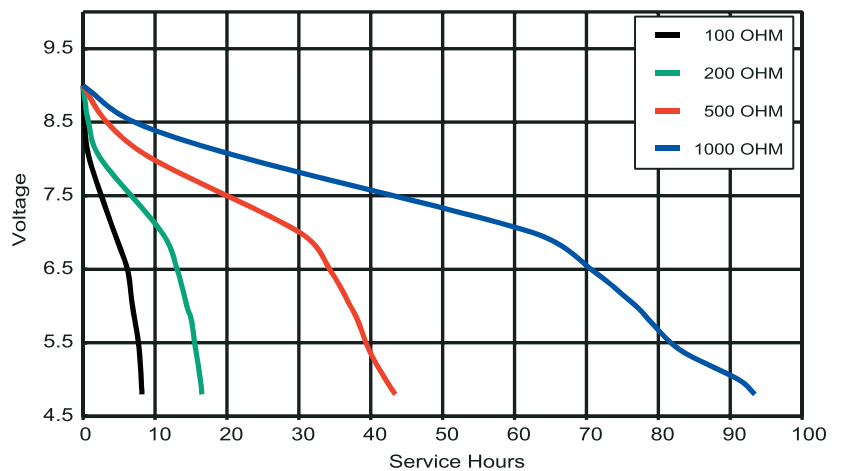

DURACELL[®] BATTERIES

Berkshire Corporate Park
Bethel, CT 06801 U.S.A.
Telephone: Toll-free 1-800-544-5454
Internet: www.duracell.com

* Delivered capacity is dependent on the applied load, operating temperature and cut-off voltage. Please refer to the charts and discharge data shown for examples of the energy / service life that the battery will provide for various load conditions.

TYPICAL CONSTANT CURRENT DISCHARGE CHARACTERISTICS AT 21°C (70°F)

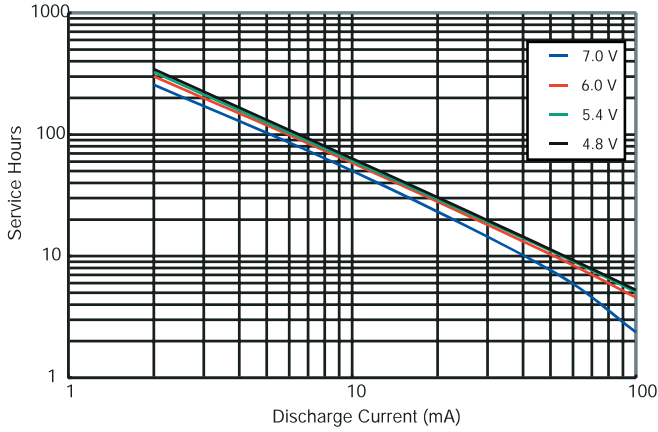

TYPICAL DISCHARGE CHARACTERISTICS AT 21°C (70°F)

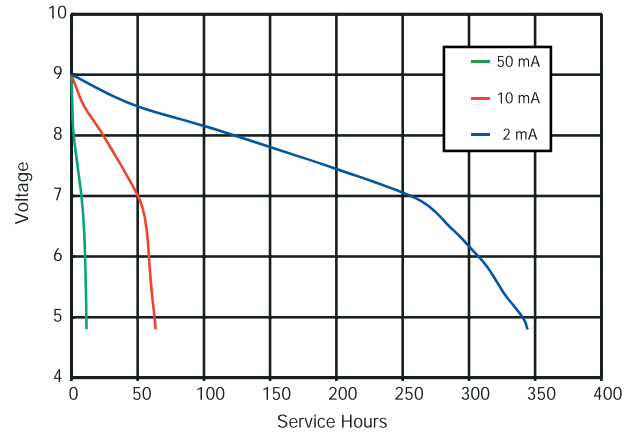

TYPICAL DISCHARGE CHARACTERISTICS AT 21°C (70°F)

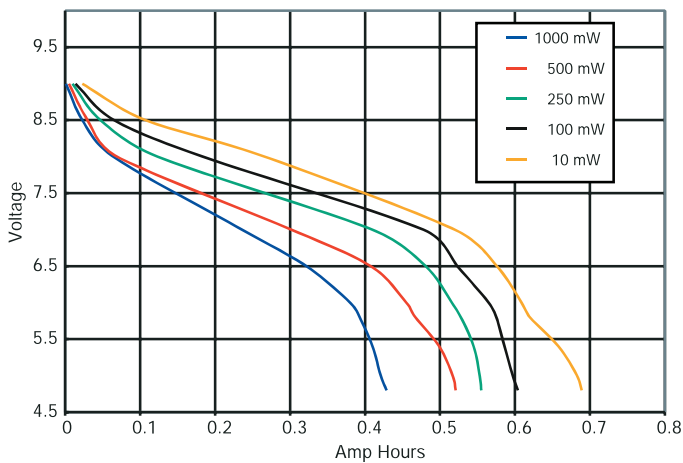

TYPICAL TOY TEST AT 21°C AND 0°C

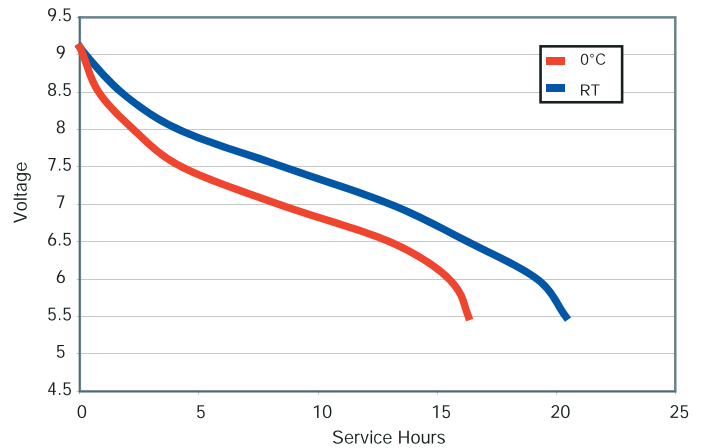

DURACELL[®] BATTERIES

Berkshire Corporate Park
Bethel, CT 06801 U.S.A.
Telephone: Toll-free 1-800-544-5454
Internet: www.duracell.com

* Delivered capacity is dependent on the applied load, operating temperature and cut-off voltage. Please refer to the charts and discharge data shown for examples of the energy / service life that the battery will provide for various load conditions.

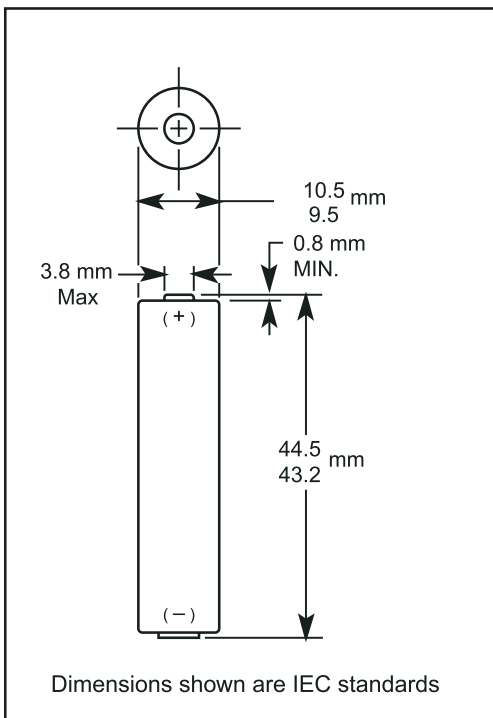

Nominal Voltage:	1.5 V
Operating Voltage	1.6 - 0.75V
Impedance:	250 m-ohm @ 1kHz
Typical Weight:	11 gm (0.4 oz.)
Typical Volume:	3.5 cm ³ (0.2 in. ³)
Terminals:	Flat
Storage Temperature Range:	-20°C to 35°C
Operating Temperature Range:	-20°C to 54°C (-4°F to 130°F)
ANSI:	24A
IEC:	LR03

DURACELL[®]

BATTERIES

Berkshire Corporate Park
Bethel, CT 06801 U.S.A.
Telephone: Toll-free 1-800-544-5454
Internet: www.duracell.com

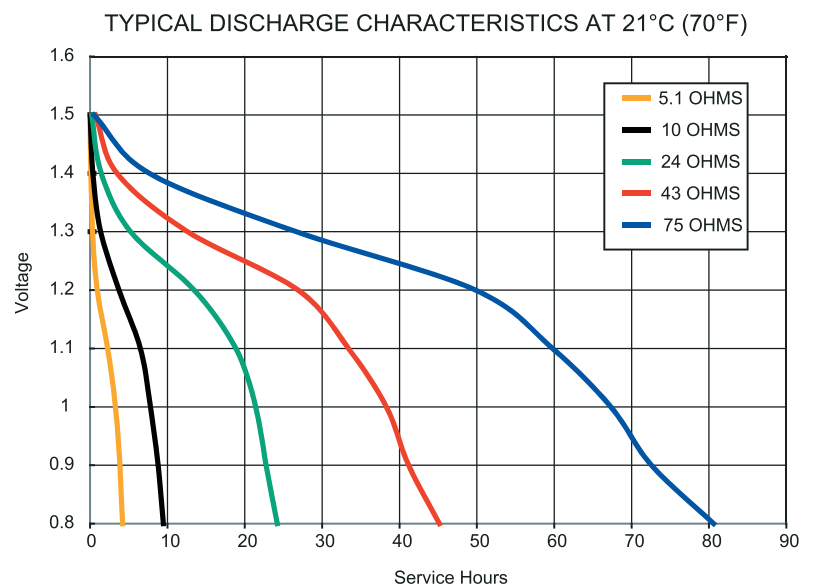

* Delivered capacity is dependent on the applied load, operating temperature and cut-off voltage. Please refer to the charts and discharge data shown for examples of the energy / service life that the battery will provide for various load conditions.

TYPICAL CONSTANT CURRENT DISCHARGE CHARACTERISTICS AT 21°C (70°F)

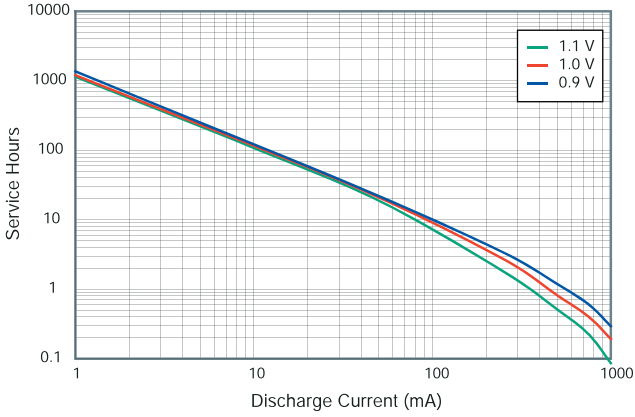

TYPICAL DISCHARGE CHARACTERISTICS AT 21°C (70°F)

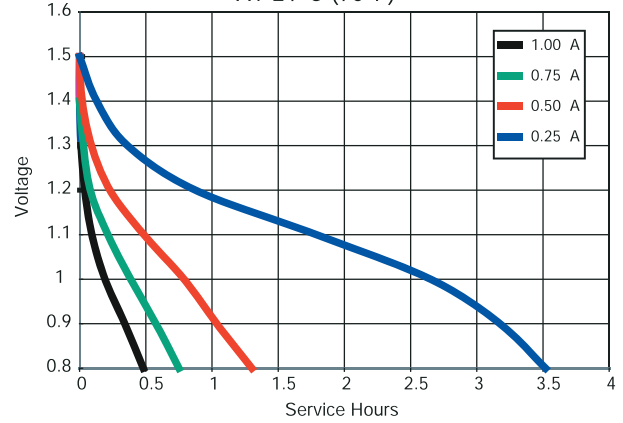

TYPICAL DISCHARGE CHARACTERISTICS AT 21°C (70°F)

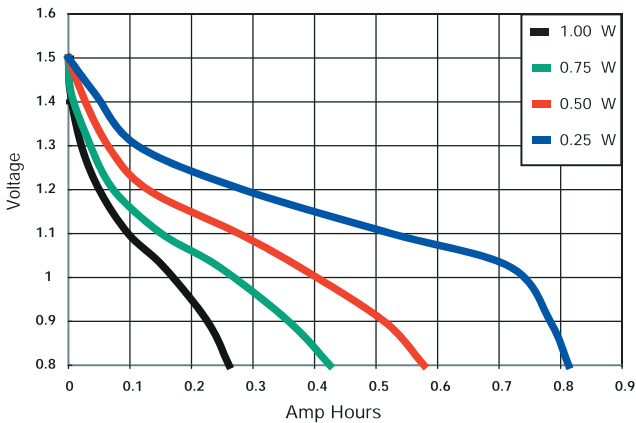

TYPICAL DISCHARGE PERFORMANCE AT 21°C (70°F)

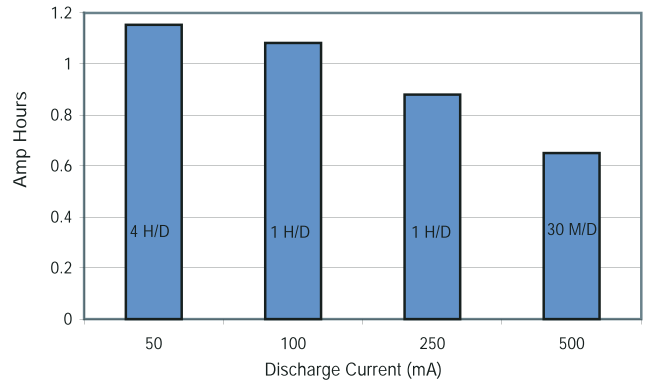

TYPICAL DC RESISTANCE CHARACTERISTICS AT 21°C (70°F)

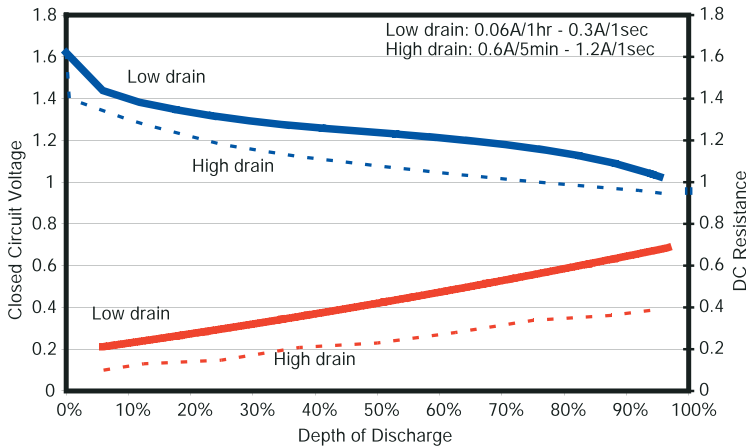

DURACELL[®] BATTERIES

Berkshire Corporate Park
Bethel, CT 06801 U.S.A.
Telephone: Toll-free 1-800-544-5454
Internet: www.duracell.com

* Delivered capacity is dependent on the applied load, operating temperature and cut-off voltage. Please refer to the charts and discharge data shown for examples of the energy / service life that the battery will provide for various load conditions.