



**DX1500**

Size: AA 1950 mAh (HR6)  
Rechargeable NiMH Battery



**Technical Specifications**

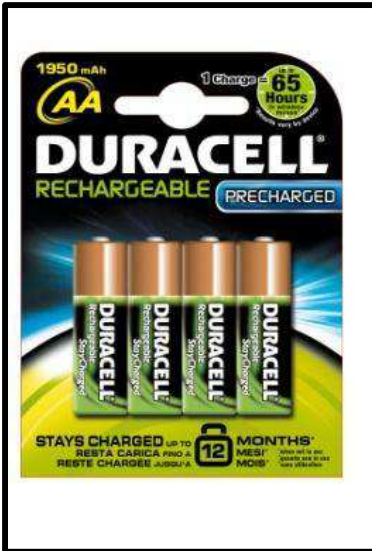

<b>Classification:</b>	Cylindrical Rechargeable
<b>Chemical system</b>	Nickel Metal Hydride (Ni-MH)
<b>Designation:</b>	IEC – HR6
<b>Nominal Voltage:</b>	1.2V
<b>Operating Voltage:</b>	1.0V-1.35V
<b>Operating temp:</b>	-10°C to 50°C
<b>Storage Temp:</b>	5°C – 30°C
<b>Typical weight:</b>	28g
<b>Typical Volume:</b>	8.3 cubic centimeters
<b>Typical Impedance:</b>	20 milliohm @ 1 khz
<b>Rated Capacity:</b>	1950 mAh
<b>Safety Features:</b>	Pressure released resettable vent

**BENEFITS**

- Stays charged for up to 12 months.\*
- Pre-charged, ready to use out of the package.
- 1 charge up to 65 hours in wireless mouse
- 1 charge up to 19 hours in gaming controller
- 1 charge up to 375 pictures

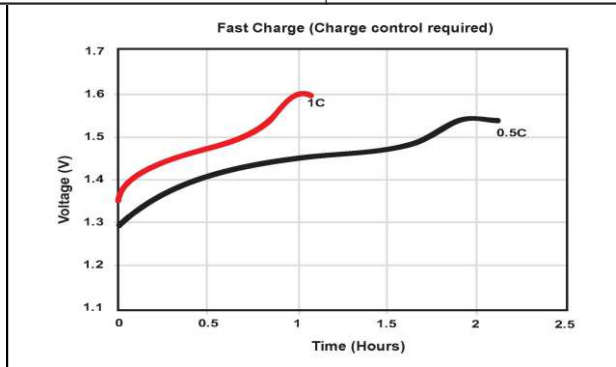
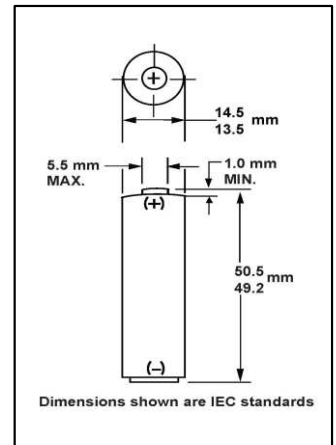
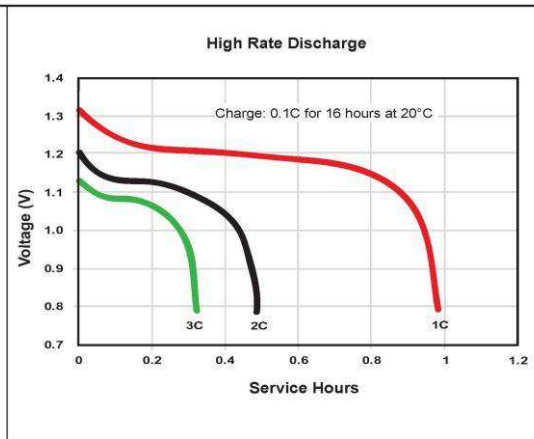
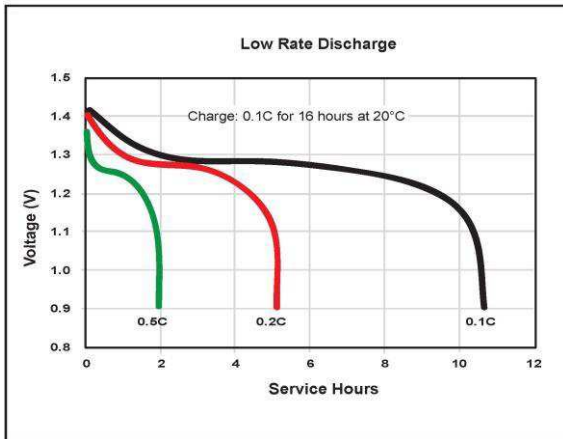

**DURACELL®**  
BATTERIES

Berkshire Corporate Park  
Bethel, CT 06801 U.S.A.  
Tel: Toll free 1.800.544.5454  
Web: www.Duracell.com

\*When not in use.

Information and contents in this data sheet are for reference purposes only. They do not constitute any warranty and representation is subject to change without notice. For most current information and further details, please contact Duracell.



**DX2400**

Size: AAA 800 mAh (HR3)  
Rechargeable NiMH Battery

**NiMH**

**Technical Specifications**



<b>Classification:</b>	Cylindrical Rechargeable
<b>Chemical system</b>	Nickel Metal Hydride (Ni-MH)
<b>Designation:</b>	IEC – HR3
<b>Nominal Voltage:</b>	1.2V
<b>Operating Voltage:</b>	1.0V-1.35V
<b>Operating temp:</b>	-10°C to 50°C
<b>Storage Temp:</b>	5°C – 30°C
<b>Typical weight:</b>	12.8g
<b>Typical Volume:</b>	3.5 cubic centimeters
<b>Typical Impedance:</b>	30 milliohm @ 1 khz
<b>Rated Capacity:</b>	800 mAh
<b>Safety Features:</b>	Pressure released resettable vent

**BENEFITS**

- Stays charged for up to 12 months.\*
- Pre-charged, ready to use out of the package.
- 1 charge up to 45 hours in wireless mouse
- 1 charge up to 7.5 hours in gaming controller
- 1 charge up to 250 pictures

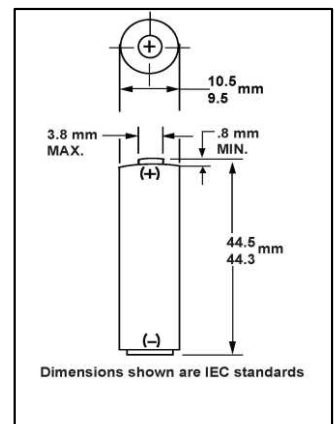
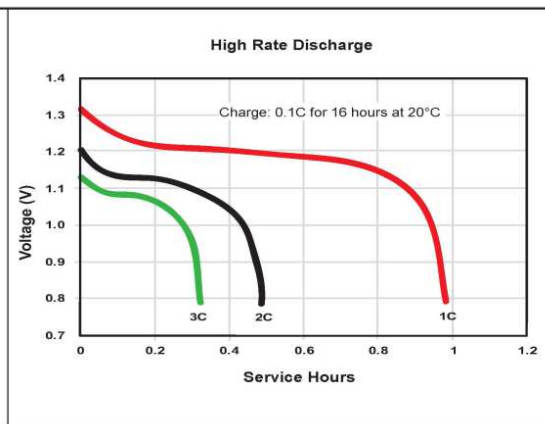
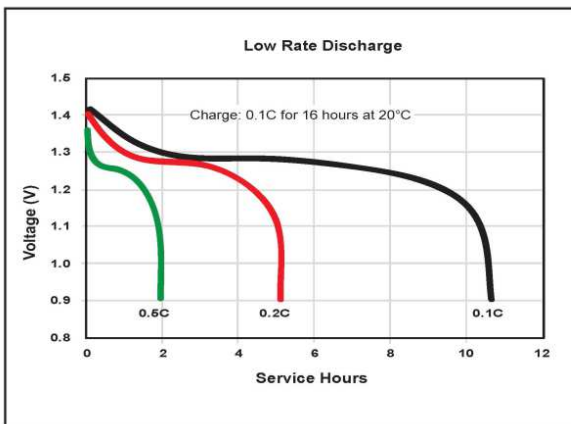

**DURACELL®**  
BATTERIES

Berkshire Corporate Park  
Bethel, CT 06801 U.S.A.  
Tel: Toll free 1.800.544.5454  
Web: www.Duracell.com

\*When not in use.

Information and contents in this data sheet are for reference purposes only. They do not constitute any warranty and representation is subject to change without notice. For most current information and further details, please contact Duracell.

Document #: CH-A

**DURACELL®**  
Rechargeable

**DX2400**

Size: 9V 170 mAh (HR3)  
Rechargeable NiMH Battery

**NiMH**

**Technical Specifications**



<b>Classification:</b>	Cylindrical Rechargeable
<b>Chemical system</b>	Nickel Metal Hydride (Ni-MH)
<b>Designation:</b>	IEC – HR3
<b>Nominal Voltage:</b>	8.4V
<b>Operating Voltage:</b>	7.0V-9.5V
<b>Operating temp:</b>	-10°C to 50°C
<b>Storage Temp:</b>	5°C – 30°C
<b>Typical weight:</b>	42g
<b>Typical Volume:</b>	22.8 cubic centimeters
<b>Typical Impedance:</b>	2000 milliohm @ 1 khz
<b>Rated Capacity:</b>	170 mAh
<b>Safety Features:</b>	Short Circuit Protection

**BENEFITS**

Reliable performance in everyday devices  
1 charge up to 5 hours in toy

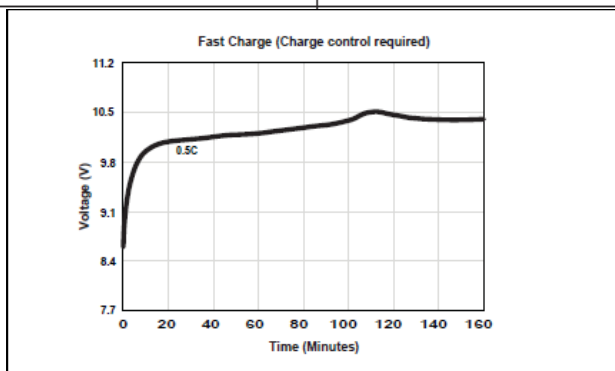
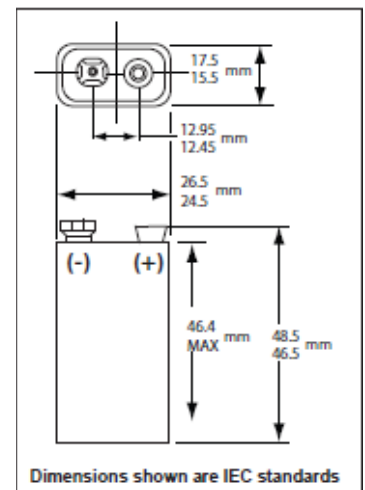
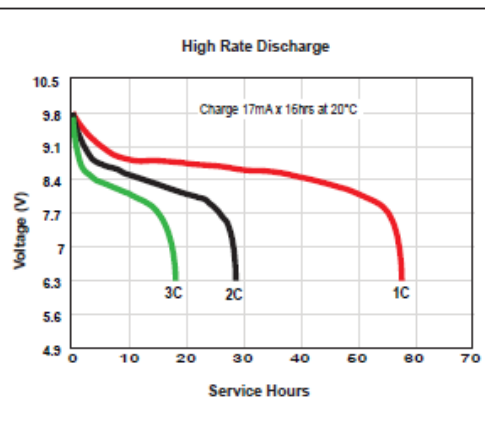
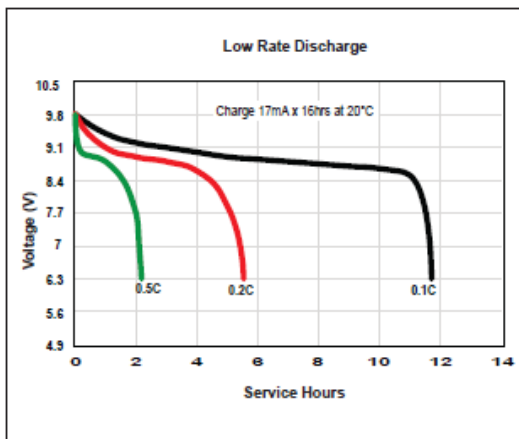

**DURACELL®**  
BATTERIES

Berkshire Corporate Park  
Bethel, CT 06801 U.S.A.  
Tel: Toll free 1.800.544.5454  
Web: [www.Duracell.com](http://www.Duracell.com)

Information and contents in this data sheet are for reference purposes only. They do not constitute any warranty and representation is subject to change without notice. For most current information and further details, please contact Duracell.

Document #: CH-A

# DURACELL®

Rechargeable

# DX1500

Size: AA 2400 mAh (HR6)  
Rechargeable NiMH Battery

**NiMH**

## Technical Specifications



<b>Classification:</b>	Cylindrical Rechargeable
<b>Chemical system</b>	Nickel Metal Hydride (Ni-MH)
<b>Designation:</b>	IEC – HR6
<b>Nominal Voltage:</b>	1.2V
<b>Operating Voltage:</b>	1.0V-1.35V
<b>Operating temp:</b>	-10°C to 50°C
<b>Storage Temp:</b>	5°C – 30°C
<b>Typical weight:</b>	28g
<b>Typical Volume:</b>	8.3 cubic centimeters
<b>Typical Impedance:</b>	20 milliohm @ 1 khz
<b>Rated Capacity:</b>	2400 mAh
<b>Safety Features:</b>	Pressure released resettable vent

### BENEFITS

- 1 charge up to 75 hours in wireless mouse
- 1 charge up to 20 hours in gaming controller
- 1 charge up to 450 pictures

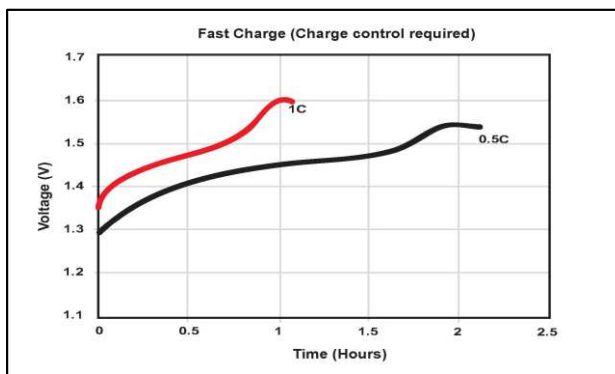
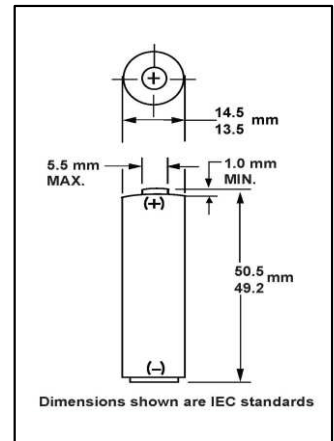
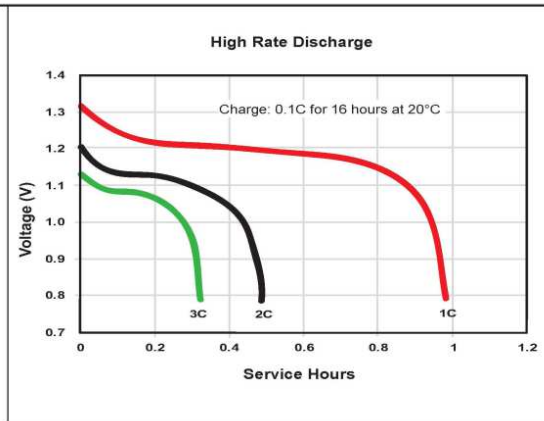
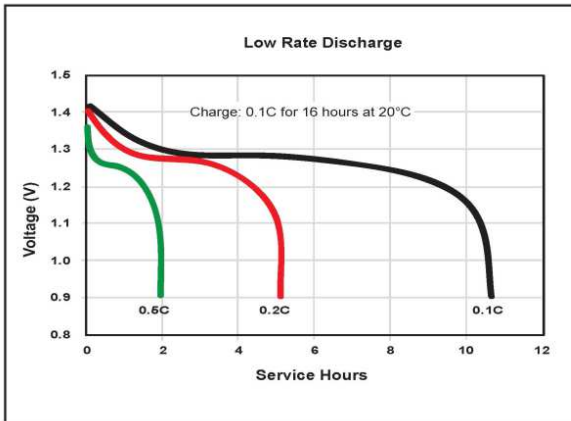

**DURACELL®**  
BATTERIES

Berkshire Corporate Park  
Bethel, CT 06801 U.S.A.  
Tel: Toll free 1.800.544.5454  
Web: www.Duracell.com

Information and contents in this data sheet are for reference purposes only. They do not constitute any warranty and representation is subject to change without notice. For most current information and further details, please contact Duracell.

Document #: CH-A

# DURACELL®

Rechargeable

# DX2400

Size: AAA 950 mAh (HR3)  
Rechargeable NiMH Battery

# NiMH

## Technical Specifications



<b>Classification:</b>	Cylindrical Rechargeable
<b>Chemical system</b>	Nickel Metal Hydride (Ni-MH)
<b>Designation:</b>	IEC – HR3
<b>Nominal Voltage:</b>	1.2V
<b>Operating Voltage:</b>	1.0V-1.35V
<b>Operating temp:</b>	-10°C to 50°C
<b>Storage Temp:</b>	5°C – 30°C
<b>Typical weight:</b>	12.8g
<b>Typical Volume:</b>	3.5 cubic centimeters
<b>Typical Impedance:</b>	30 milliohm @ 1 khz
<b>Rated Capacity:</b>	950 mAh
<b>Safety Features:</b>	Pressure released resettable vent

### BENEFITS

- 1 charge up to 55 hours in wireless mouse
- 1 charge up to 9 hours in gaming controller
- 1 charge up to 300 pictures

Low Rate Discharge

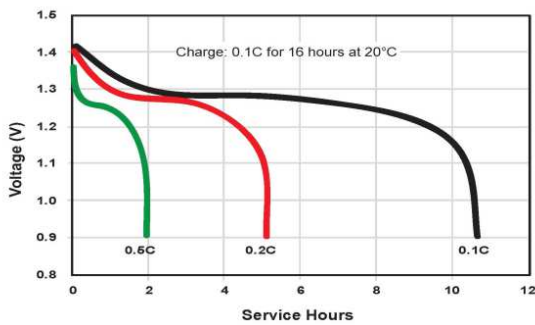

High Rate Discharge

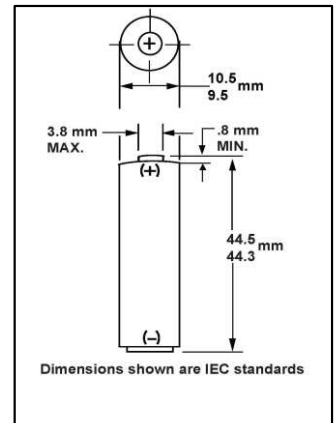
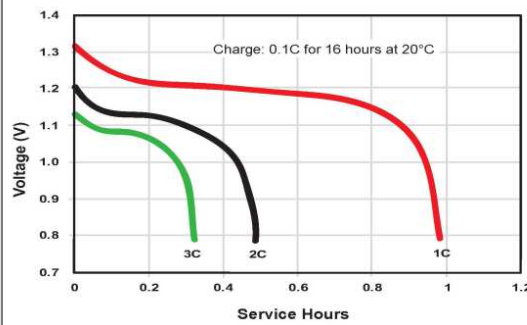

Fast Charge (Charge control required)

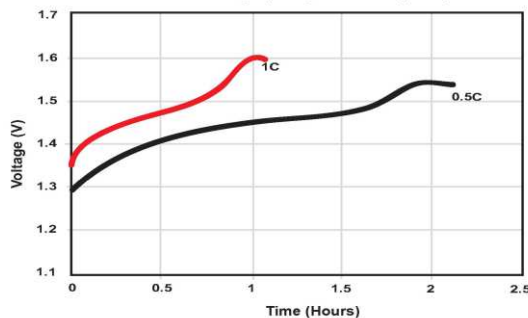

## DURACELL®

BATTERIES

Berkshire Corporate Park  
Bethel, CT 06801 U.S.A.  
Tel: Toll free 1.800.544.5454  
Web: [www.Duracell.com](http://www.Duracell.com)

Information and contents in this data sheet are for reference purposes only. They do not constitute any warranty and representation is subject to change without notice. For most current information and further details, please contact Duracell.

Document #: CH-A

**DURACELL®**  
Rechargeable

**DC1400**

Size: C 2200mAh (HR14)  
Rechargeable NiMH Battery

**NiMH**

**Technical Specifications**



Classification:	Cylindrical Rechargeable
Chemical system	Nickel Metal Hydride (Ni-MH)
Designation:	IEC – HR14
Nominal Voltage:	1.2V
Operating Voltage:	1.0V-1.35V
Operating temp:	-10°C to 50°C
Storage Temp:	5°C – 30°C
Typical weight:	61g
Typical Volume:	26.9 cubic centimeters
Typical Impedance:	30 milliohm @ 1 khz
Rated Capacity:	2200 mAh
Safety Features:	Pressure released resettable vent

**BENEFITS**

Reliable performance in everyday devices  
1 charge up to 6 hours in toys

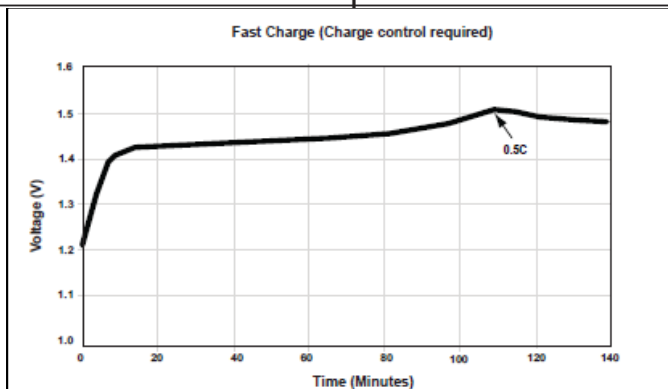
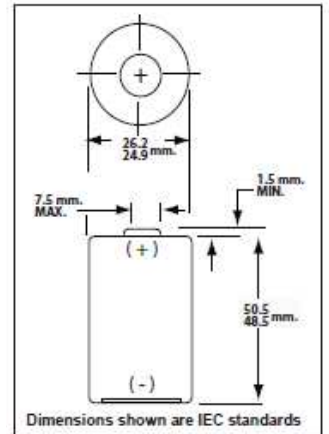
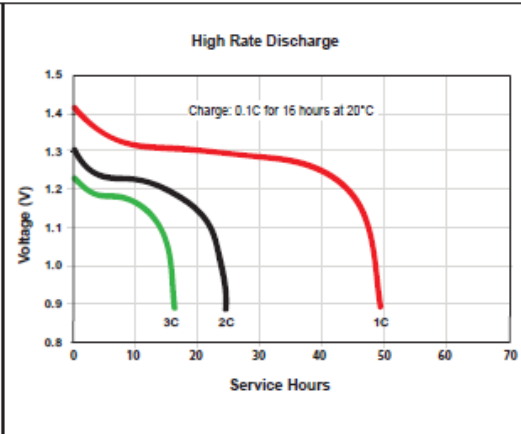
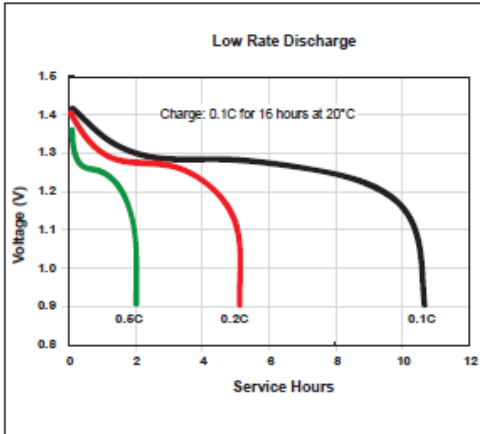

**DURACELL®**  
BATTERIES

Berkshire Corporate Park  
Bethel, CT 06801 U.S.A.  
Tel: Toll free 1.800.544.5454  
Web: www.Duracell.com

Information and contents in this data sheet are for reference purposes only. They do not constitute any warranty and representation is subject to change without notice. For most current information and further details, please contact Duracell.

Document #: CH-A

**DURACELL®**  
Rechargeable

**DC1300**

Size: D 2200mAh (HR20)  
Rechargeable NiMH Battery

**NiMH**

**Technical Specifications**



Classification:	Cylindrical Rechargeable
Chemical system	Nickel Metal Hydride (Ni-MH)
Designation:	IEC – HR20
Nominal Voltage:	1.2V
Operating Voltage:	1.0V-1.35V
Operating temp:	-10°C to 50°C
Storage Temp:	5°C – 30°C
Typical weight:	71g
Typical Volume:	56.4 cubic centimeters
Typical Impedance:	45 milliohm @ 1 khz
Rated Capacity:	2200 mAh
Safety Features:	Pressure released resettable vent

**BENEFITS**

Reliable performance in everyday devices  
1 charge up to 3 hours in toy

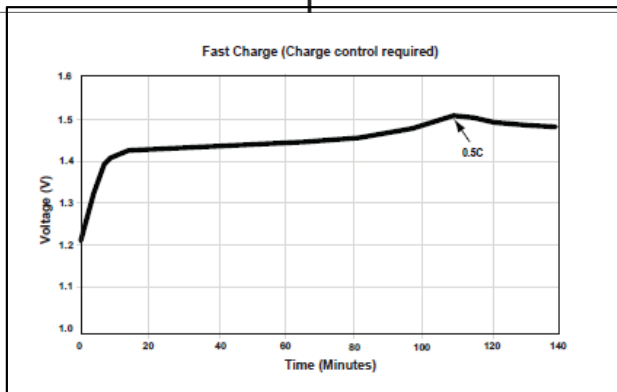
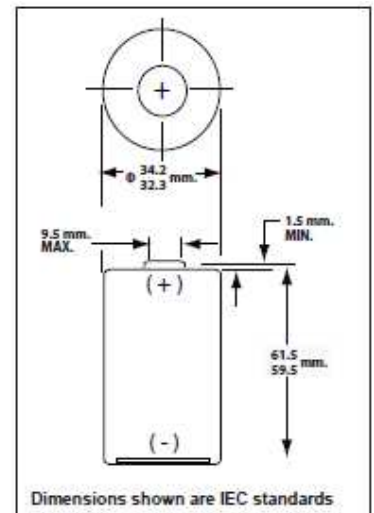
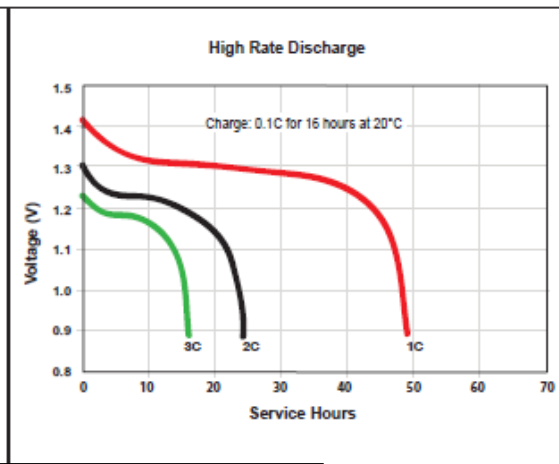
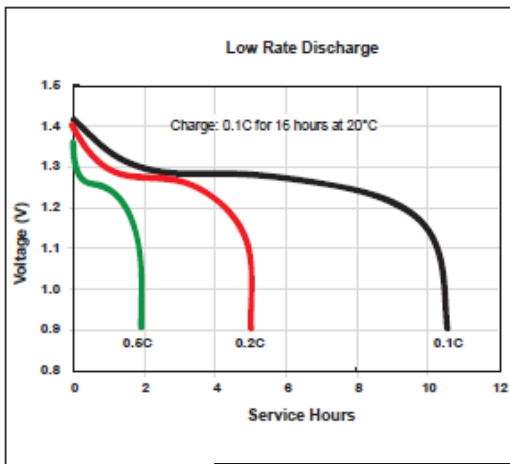

**DURACELL®**  
BATTERIES

Berkshire Corporate Park  
Bethel, CT 06801 U.S.A.  
Tel: Toll free 1.800.544.5454  
Web: www.Duracell.com

Information and contents in this data sheet are for reference purposes only. They do not constitute any warranty and representation is subject to change without notice. For most current information and further details, please contact Duracell.

# DURACELL®

Rechargeable

## DC1500

Size: AA 1300 mAh (HR6)  
Rechargeable NiMH Battery

NiMH

### Technical Specifications



Classification:	Cylindrical Rechargeable
Chemical system	Nickel Metal Hydride (Ni-MH)
Designation:	IEC – HR6
Nominal Voltage:	1.2V
Operating Voltage:	1.0V-1.35V
Operating temp:	-10°C to 50°C
Storage Temp:	5°C – 30°C
Typical weight:	28g
Typical Volume:	8.3 cubic centimeters
Typical Impedance:	20 milliohm @ 1 khz
Rated Capacity:	1300 mAh
Safety Features:	Pressure released resettable vent

### BENEFITS

- Stays charged for up to 6 months.\*
- 1 charge up to 60 hours in wireless mouse
- 1 charge up to 13 hours in gaming controller
- 1 charge up to 270 pictures

Low Rate Discharge

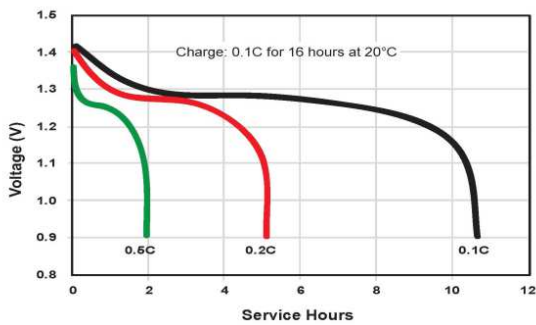

High Rate Discharge

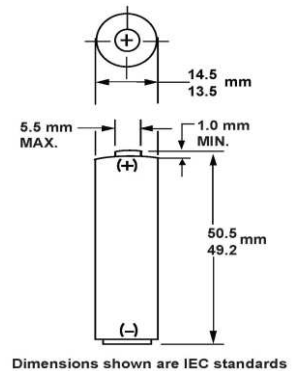
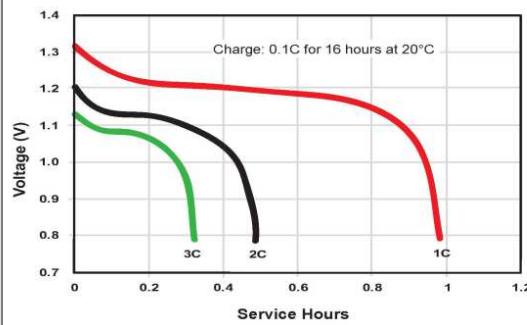

Fast Charge (Charge control required)

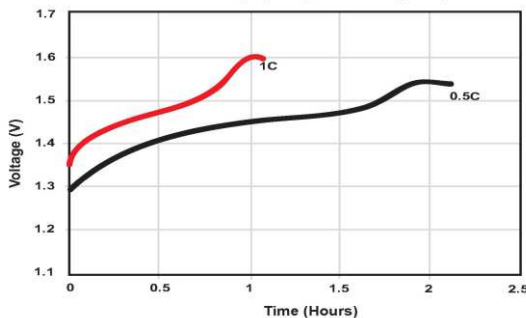

## DURACELL®

BATTERIES

Berkshire Corporate Park  
Bethel, CT 06801 U.S.A.  
Tel: Toll free 1.800.544.5454  
Web: [www.Duracell.com](http://www.Duracell.com)

\*When not in use.

Information and contents in this data sheet are for reference purposes only. They do not constitute any warranty and representation is subject to change without notice. For most current information and further details, please contact Duracell.

Document #: CH-A



# DURACELL®

Rechargeable

## DX2400

Size: AAA 750 mAh (HR3)  
Rechargeable NiMH Battery

NiMH

### Technical Specifications

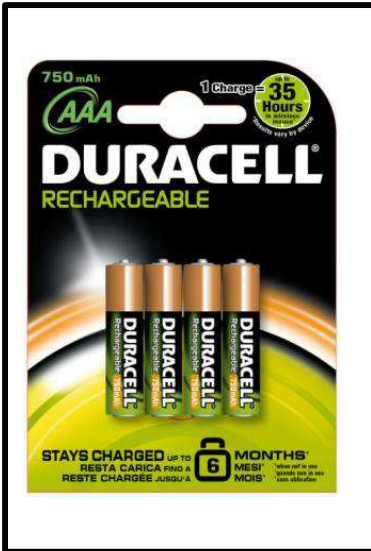

Classification:	Cylindrical Rechargeable
Chemical system	Nickel Metal Hydride (Ni-MH)
Designation:	IEC – HR3
Nominal Voltage:	1.2V
Operating Voltage:	1.0V-1.35V
Operating temp:	-10°C to 50°C
Storage Temp:	5°C – 30°C
Typical weight:	12.8g
Typical Volume:	3.5 cubic centimeters
Typical Impedance:	30 milliohm @ 1 khz
Rated Capacity:	750 mAh
Safety Features:	Pressure released resettable vent

### BENEFITS

Stays charged for up to 6 months.\*  
1 charge up to 35 hours in wireless mouse

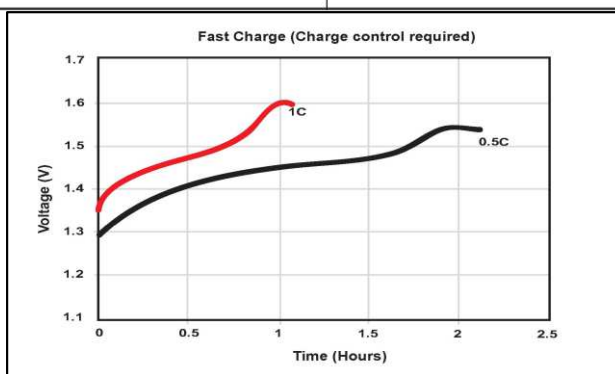
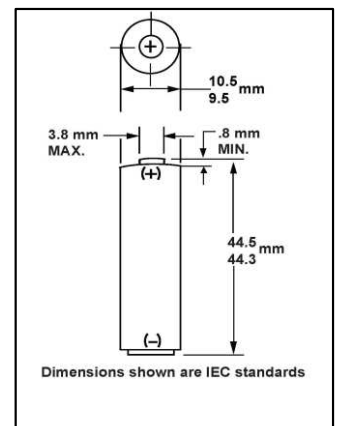
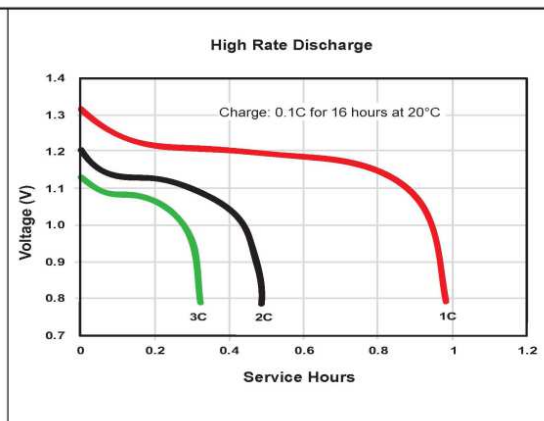
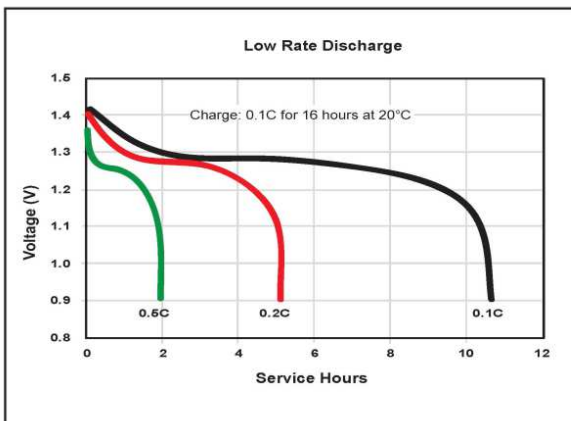

**DURACELL®**  
BATTERIES

Berkshire Corporate Park  
Bethel, CT 06801 U.S.A.  
Tel: Toll free 1.800.544.5454  
Web: www.Duracell.com

\*When not in use.

Information and contents in this data sheet are for reference purposes only. They do not constitute any warranty and representation is subject to change without notice. For most current information and further details, please contact Duracell.

Document #: CH-A

# DURACELL®

Rechargeable

## DX2400

Size: AAA 750 mAh (HR3)  
Rechargeable NiMH Battery

NiMH

### Technical Specifications

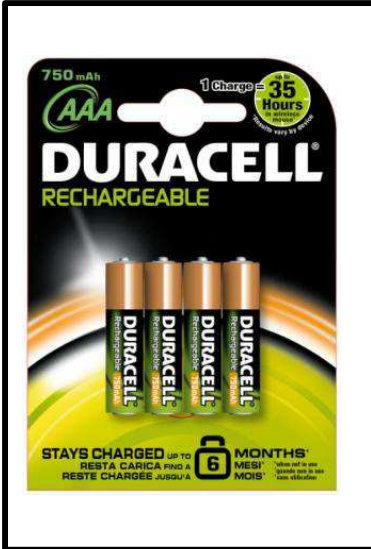

Classification:	Cylindrical Rechargeable
Chemical system	Nickel Metal Hydride (Ni-MH)
Designation:	IEC – HR3
Nominal Voltage:	1.2V
Operating Voltage:	1.0V-1.35V
Operating temp:	-10°C to 50°C
Storage Temp:	5°C – 30°C
Typical weight:	12.8g
Typical Volume:	3.5 cubic centimeters
Typical Impedance:	30 milliohm @ 1 khz
Rated Capacity:	750 mAh
Safety Features:	Pressure released resettable vent

### BENEFITS

Stays charged for up to 6 months.\*  
1 charge up to 35 hours in wireless mouse

Low Rate Discharge

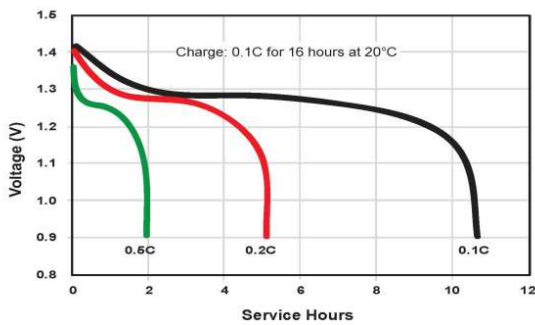

High Rate Discharge

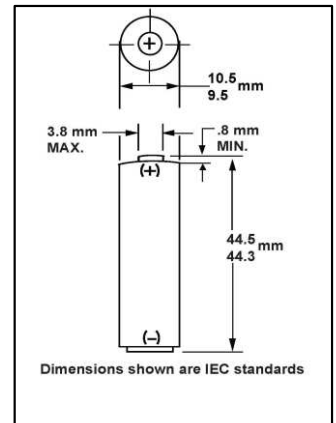
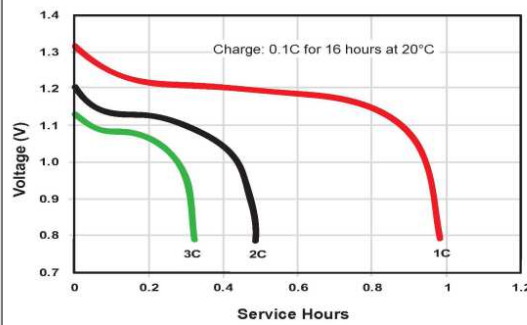

Fast Charge (Charge control required)

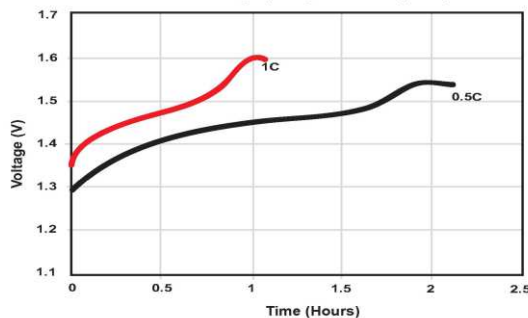

**DURACELL®**  
BATTERIES

Berkshire Corporate Park  
Bethel, CT 06801 U.S.A.  
Tel: Toll free 1.800.544.5454  
Web: [www.Duracell.com](http://www.Duracell.com)

\*When not in use.

Information and contents in this data sheet are for reference purposes only. They do not constitute any warranty and representation is subject to change without notice. For most current information and further details, please contact Duracell.

Document #: CH-A